

Polycom® KIRK® 4020/4040



User Guide



Congratulations on your new KIRK handset

Your new KIRK handset will provide you with the greatest possible degree of flexibility and mobility due to high battery capacity, low weight, practical size and design.



Contents:

1. Construction	4	7.5.4 Remove subscription.....	26
2. Battery installation	5	7.5.5 Change startup text.....	26
3. Charging	6	7.6 Battery capacity	27
4. Key functions	7	7.7 Redial	28
5. Turning the handset ON/OFF	9	7.8 Book.....	30
6. Making a call.....	10	7.9 External services.....	32
6.1 Receiving calls	12	7.10 MSF Functions	33
6.2 During conversation	13	7.11 Mail/Textmessages.....	34
6.2.1 Volume regulation.....	13	7.12 Speed dial	38
6.2.2 Microphone mute.....	13	8. Date and Time function	39
6.2.3 Transferring the call to another handset.....	13	9. Language	40
7. Menu structure	14	10. Advanced settings.....	41
7.1 Using the alphanumeric keyboard.....	15	11. Shortcuts	44
7.2 The key functions.....	16	12. Information	45
7.3 Profile set up	17	12.1 Error tree	45
7.4 Profile functions	19	12.2 Error information	46
7.5 Menu subscription and login.....	21	12.3 Polycom® Product Warranty Statement	46
7.5.1 Create subscription	22	12.4 Technical Information	62
7.5.2 Login.....	23	12.5 International Regulatory and Product Information	63
7.5.3 Auto login.....	24	12.5.1 Important Safety Instructions.....	67
		12.5.2 Limited Warranty	72

1. Construction

MENU key

Key for internal calls
(not used on KIRK Wireless Server)
Loud speaking (only KIRK 4040)

Keyboard LOCK
(Menu*)

Recall key
(MAIL key)

SILENT (Menu#)

Headset Connector
(only KIRK 4040)

4
Display with backlight

Left arrow key, Redial Menu
from standby text

LED

Alarm key

Right arrow key, save number.
Phone book Menu from stand-
by text

CONFIRMATION key -
MUTE microphone.
MUTE ringer when ringing.
Long key press turns off

Volume up/down

ON/OFF HOOK key-
also used as turn on key





2. Battery installation

The battery is connected to the handset when it is shipped from the factory. To change the battery you must unscrew the plate on the rear of the handset to access the battery compartment.



To remove the battery cover, use a normal screw driver. Insert it into the small crack behind the blind cover and break to open the handset.

Please note: The product label, including the CE logo, can be found in the battery compartment.



3. Charging

During normal operation, it takes approximately 3 1/2 hours to charge the handset from fully discharged to its full capacity. Place the handset in the charger. When the handset is turned on, the display shows the charging status in line 3. For correct charging be sure the room temperature is between 0°C and 25°C. Do not place the handset in direct sunlight. The battery has a built-in heat sensor which will stop charging if the battery temperature is too high. It is necessary to recharge the battery when the display shows "BATTERY LOW", or if it can not be turned on. The LED flashes at a low frequency while charging and lights constantly when the charging is finished. The display goes back to normal mode when fully charged.

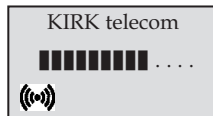

When the handset is placed in the charger it will not vibrate, and B-answer is inactive. If the battery is fully discharged, up to 10 min. may pass before charging begins and the handset can be turned on. When the charger begins the charging, status is shown in the 3rd line of the display and the LED flashes slowly.



4. Key Functions

The handset has 21 keys:

Two keys are placed at the right side for volume control. Press upper or lower key to change the volume. Each key-press turns volume one step up/down.

- "MENU" - Go to menu structure or exits the menu structure. (Escape or "NO")
- " < ", "REDIAL" - Menu: left, Cursor left, after a digit: delete last digit. Long press: delete all
From standby text: Redial Menu
- " > ", "BOOK" - Menu: right, Cursor right, After a digit: Store number in telephone book
From standby text: Telephone book read
- "✓", "MUTE" - Confirmation ("YES") or jump to next level in the menu. In off hook: Mute microphone
In on hook: Mute ringer. Long key press turns the handset OFF





8

- “INT” - If residential systems: Internal calls off hook
(not used on KIRK Wireless Server)
Turns loudspeaking on and off in off hook (only KIRK 4040)
- “R” - If off hook: Recall. If on hook: Read or write message
- “” - On hook/off hook and turn ON
- “ * ” - * (Change from pulse to DTMF on KIRK Wireless Server), Long = pause (-), extra long: change from pulse to DTMF (a “T” appears in the display, GAP standard)
- “0-9” - Digits or letters in alphanumeric mode (names and messages)
- “ * * ” - * , Choose uppercase or lowercase letters in alphanumeric mode





5. Turning the handset ON/OFF

ON: Press -key for 1/2 second.

When the handset is turned on the  symbol is shown in the lower left corner of the display, if the handset is subscribed to a system. (For subscription, see Chap. 7.5.1)



OFF: Press the -key (MUTE) for 3 seconds

Please note: When the handset has been outside the coverage area, it can take up to 30 seconds before the handset is back on the system after re-entering the coverage area.





6. Making a call

For making or receiving calls the handset has to be subscribed to a system ( shown in display) (see Chap. 7.5.1). Press the -key, the -icon in the display will flash until connection is established. Dial the number.

Pre-dial:

Press the number to dial (long press on * will make a pause, if necessary). Press the -key, the -icon will flash until the connection is established.

Telephone book:

Press the > -key (BOOK) to enter the telephone book.

Search for the number either by using the < or > -keys or by pressing the first letter in the name by using the digits 1 - 9 (see Chap. 7.2).

Press the -key, the -icon will flash until the connection is established.





Redial:

Redial / CLIP (CLIP = Calling Line Identification Presentation) stack:

Press the <-key (REDIAL) to enter the redial/CLIP stack.

Search for the number by using the < or >-keys, redial numbers are marked with "REDIAL" or name and clip numbers are marked either with "CLIP" or the name of the person who called and the LED is on.

Press the -key, the -icon will flash until the connection is established.

Using the handset in residential systems: (not on KIRK Wireless Server)

Internal call post-dial:

Press the INT-key, the -icon in the display will flash.

Dial the number of another handset on the base station, the -icon will flash until the connection is established.

Internal call pre-dial: (not on KIRK Wireless Server)

Press the number of another handset on the base station.

Press the INT-key, the -icon will flash until the connection is established.





Please note: If the Date and Time function is supported, then date and time of the incoming or outgoing call is shown in the CLIP/Redial stack on the 4th line of the display. See Chap. 8 for more information.

Speed dial:

See Chap. 7.12 and Chap. 10 for more information about speed dialing.

6.1. Receiving calls

If the phone rings, the call can be answered by pressing the -key.

When ringing the LED flashes fast, and the display shows the CLIP (if presented). If it is an external call (or if no CLIP) the display shows “INCOMING CALL”.

It is possible to stop the ring signal without answering the call. Press MUTE (✓) and the ring signal is muted. Display shows: “RINGER MUTED”.





6.2 During conversation

6.2.1 Volume regulation:

Use the two keys placed at the right side of the handset for volume control.

6.2.2 Microphone mute:

Press the ✓-key (MUTE), “MIC. MUTED” is showed in the display.

Press the ✓-key (MUTE) to enable the microphone again.

6.2.3 Transferring the call to another handset:

Press the R-key, and dial new number.

Press the -key and the call is transferred to the other handset.



7. Menu structure

Pressing the MENU-key, enters or exits the menu structure. It has to be used if a “NO” or “CLEAR” is wanted in the menu structure.

Pressing the ✓-key, jumps to a lower level in the menu. When the lowest menu level is reached, it will store the setting and jump to a higher level. It has to be used if a “YES” is wanted.

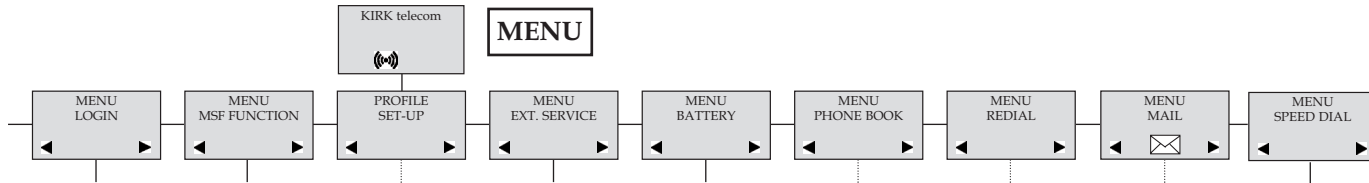

The Phone book Menu, Redial Menu and Mail Menu can be accessed directly. The Phone book Menu by pressing the > -key (BOOK), the Redial Menu by pressing the < -key (REDIAL), and the Mail Menu by pressing the R-key (MAIL).



7.1 Using the alphanumeric keyboard

The normal dialling keys (0-9) are used for writing the name to be placed in the telephone book. By pressing the keys a certain number of times the related letters or digits will appear in the display. Spaces are made by using the 0-key. Key * changes between uppercase and lowercase letters. The arrows will move the cursor. Left arrow is also used for deleting (hold for 1 sec.) = delete. New letters can be inserted.

Change of key press and pauses lasting more than 1 second automatically moves the cursor to next position.

Please note: 4th line of the display shows the possible alphanumeric keys.



7.2 The key functions

Key	Capital letter	Small letter
1	? ! 1 - + * / = & () % ¿ ¡	? ! 1 - + * / = & () % ¿ ¡
2	A B C 2 Ä Å À Á Ã Æ Ç	a b c 2 ä å à á ã æ ç
3	D E F 3 È É Ê Ë	d e f 3 è é ê ë
4	G H I 4 Ì Í Î Ï	g h i 4 ì í î ï
5	J K L 5	j k l 5
6	M N O 6 Ñ Ö Ò Ó Ô Õ Ø	m n o 6 ñ ö ò ó ô õ ø
7	P Q R S 7 ß	p q r s 7 ß
8	T U V 8 Û Ü Ú Û	t u v 8 ü ù ú û
9	W X Y Z 9	w x y z 9
0	[Space] , . 0 : ; _ " ' ^ ~	[Space] , . 0 : ; _ " ' ^ ~
*	A → a	A → a
#	# @ E \$ £ ¥ § < > { } [\]	# @ E \$ £ ¥ § < > { } [\]



7.3 Profile set-up

To set-up the handset press MENU. You are now able to switch between the different settings. Press ✓ when you find the setting you wish to change (or see). Change the setting according to your needs, confirm with ✓ and you automatically go to the next setting. Press MENU to finalize the setup.





Profile set-up (fig)

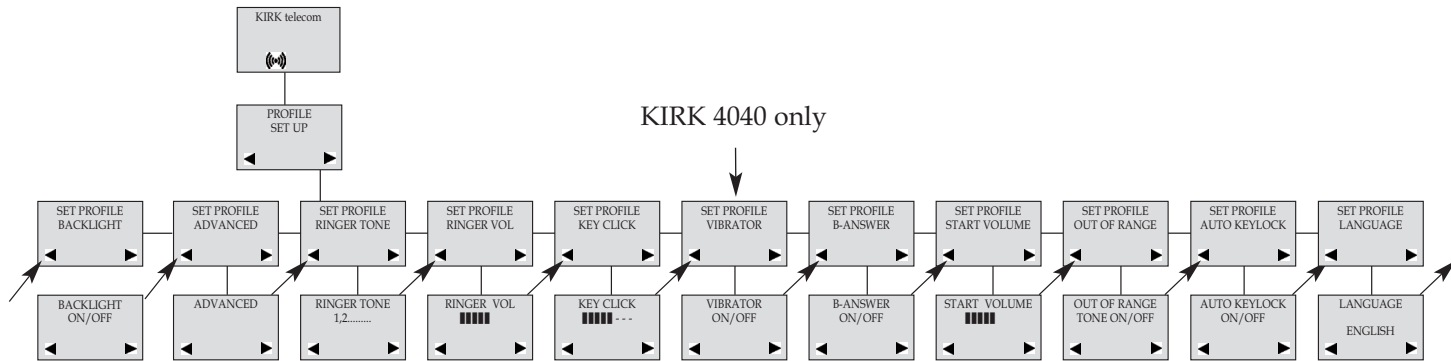



7.4 Profile functions

RINGERTONE: Scroll through the 9 different ringtones using < and >. Confirm with ✓.

RINGER VOL: Turn the volume up and down using < and >. Confirm with ✓.

KEY CLICK: Turn the volume up and down using < and >. Confirm with ✓.

VIBRATOR: Can be turned on/off using < and >. Confirm with ✓ (vibrator only works on KIRK 4040).

B-ANSWER: Can be turned on/off using < and >. Confirm with ✓. When turned on, the telephone automatically goes off hook when ringing. If subscribed to a KIRK solution it automatically goes on hook when calls are terminated.

B-answer is inactive when handset is placed in the charger.

REMARK: Automatic on-hook is only reliable under defined conditions related to the interface settings between the KIRK Wireless Server and the PBX.

START VOL: Start volume can be adjusted using < and >. Confirm with ✓.





OUT OF RANGE: The out of range indication can be turned on/off using < and >. Confirm with ✓. With the out of range indicator turned on, a beep will appear when the telephone is moving out of range of the base station, and “OUT OF RANGE” will appear in the display.

AUTO KEYLOCK: The auto keylock function can be turned on/off using < and >. Confirm with ✓. With auto keylock turned on the handset will automatically lock the keys after 30 seconds. Press MENU * to activate the keys again.

LANGUAGE: see Chap. 9.

BACKLIGHT: Can be turned on/off using < and >. Confirm with ✓.

ADVANCED: see Chap. 10.



7.5 Menu subscription and login

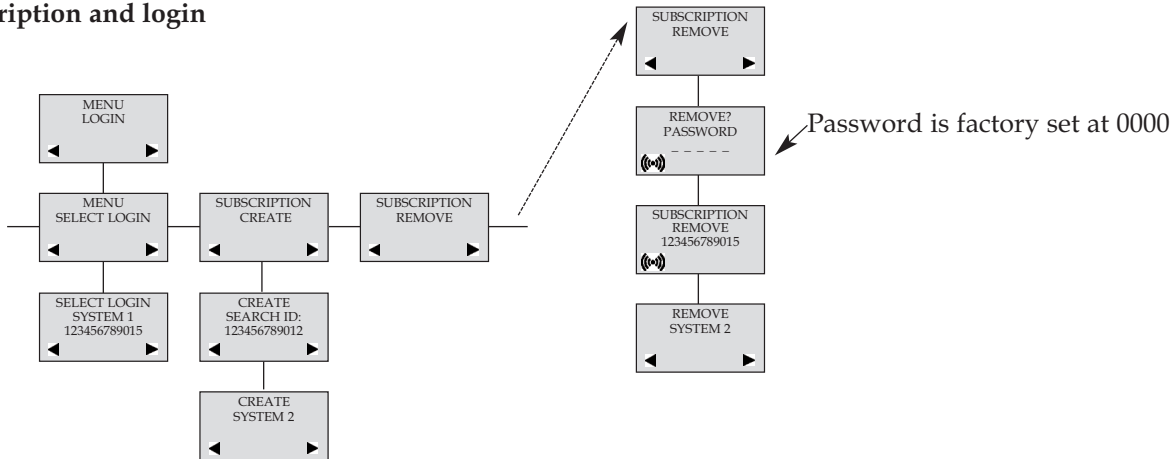

7.5.1 Create subscription

To make subscriptions, the system must allow subscriptions to be made. Some systems also require an Access Code (AC). If more than one system currently permits subscription, you will need to know the ID of the system to which you wish to subscribe. Access Codes and system ID's will be provided by the system administrator.

Choose the "SUBSCRIPTION CREATE" function to subscribe to a new system (see Chap. 7.5/7.5.4).

Use the < and > keys to scroll between the ID's of the different systems available.

During subscription the handset will search for free positions and perform subscription on the first free position.

An alternative position can be chosen using < or >. Enter the AC (if required) using the keyboard, and press ✓.

If the subscription was successful, the startup text will be replaced by the standby text given into the system by the system administrator and  is shown in the display. If not, the subscription has failed and the procedure must be retried.

If the handset is already subscribed to 10 systems, you will have to remove a subscription before creating a new subscription (see Chap. 7.5.3).

7.5.2 Login

The handset can be subscribed to 10 different systems enabling you to use the same handset on 10 different systems. If you would like to change to another system, use the Login Menu to connect to another system number. The actual chosen system is marked with a *.

To change to another system use < or > and press ✓ to confirm.

To be able to log on to a system, subscription to the system has to be established (See Chap. 7.5.1).

Under LOGIN/SELECT LOGIN only subscriptions will be shown. Free positions will not be shown.

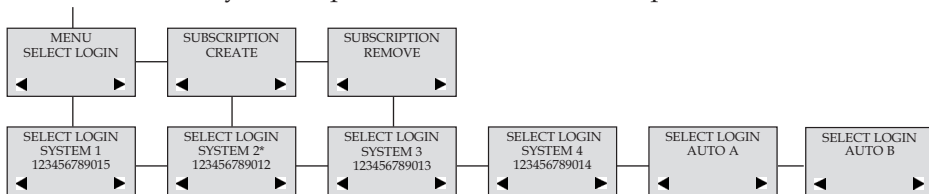



7.5.3 Auto login

The handset can be subscribed to 10 different systems.

If a handset is subscribed to two or more systems, you can use Auto Login A to change between the systems automatically. The selected system is marked with an “A”.

Please note: Auto login A should only be used in separate systems without overlaps. If a handset loses signal from the system (the display showing “OUT OF RANGE”), then after 20 seconds the handset will start searching for an alternative system available from the Login list and automatically change to this system. Changing between systems can only take place while on hook. Any call will be dropped when changing to an alternative system.





If a handset is subscribed to two systems only, you can use Auto Login B to change between the two systems automatically. The selected system is marked with a “B”.

Please note: Auto login B can be used in separate systems which are overlapping each other. As soon as the handset has measured a low radio signal 5 times in succession, it will start up the Auto login B procedure and change to an alternative system if available. Changing between two systems can only take place while on hook. Any call will be dropped when changing to an alternative system.





7.5.4 Remove subscription

Subscriptions can be removed from the system in use and from the 9 other systems (if connected). Removing a subscription requires a password. Password is factory set at 0000. If the system in use is removed, it is necessary either to select one of the remaining systems or to subscribe to a new one. If one of the systems not chosen is removed, the handset remains connected to the system in use.

7.5.5 Change startup text

The startup text is predefined as e.g. "KIRK telecom" as factory default. This can be changed by using the following procedure: Press ********, BOOK, ✓ and enter the new startup text using the keyboard followed by ✓. It is possible to insert 24 characters.

7.6 Battery capacity

In the Battery Menu it is possible to see the remaining battery capacity. For reading the correct capacity, the handset has to be removed from the charger for at least one hour. Press MENU and use the < or > keys to reach the Battery Menu. Press ✓ to enter the menu, and you can see the current status of the battery capacity. Press ✓ to return to the menu system or press MENU to quit.

The indication on the display is not necessarily an exact reflection on the remaining speech time, but only an indication of the voltage on the battery.

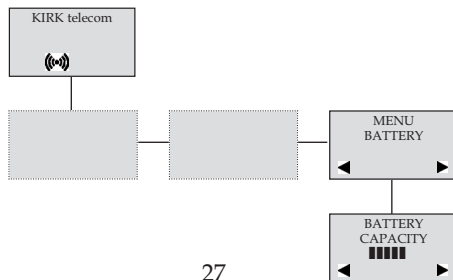

7.7 Redial

The handset has maximum 10 redial numbers and 10 Caller ID/MISSED CALL numbers placed in the same stack. Each number is only represented once. Enter the Redial Menu by pressing the <-key (REDIAL) from the standby text. Repeated presses at the <-key turn backward through the dialled numbers and CLIP numbers (from newest to the oldest). The >-key moves in the opposite direction. It is also possible to reach the Redial Menu in the main menu. Numbers are named "REDIAL", "CLIP" or with the name.

The LED will flash slowly and the display shows "MISSED CALL" if a new number has arrived in the CLIP stack. Press the <-key (REDIAL) to see the missed call.

If no number (no clip) is represented by a call only the LED will flash slow afterwards.

If you want to delete a "CLIP" or a "REDIAL" you scroll to the name/number and press ✓ twice.

The name/number is now deleted. If number is stored, it is moved to the telephone book. You can also delete all name/numbers using the "DELETE ALL?" function.

It is possible to edit the CLIP or REDIAL numbers. Find the number you wish to edit and press the digits you want to add to the number, e.g. prefix = 0.

The Redial and CLIP stack Menu (fig)

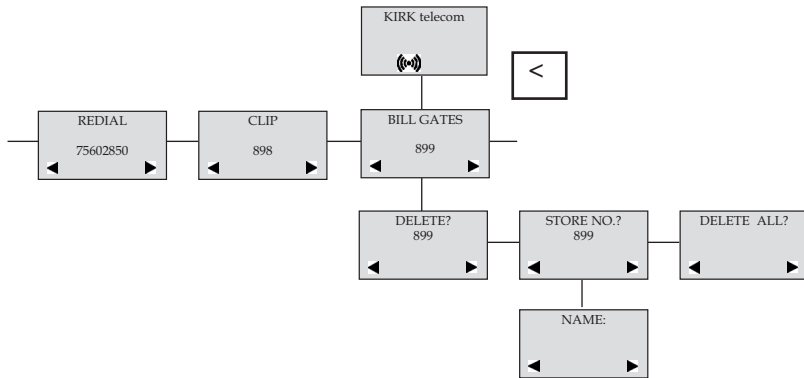

7.8 Book

Storing a number (max. 24 digits) in the telephone book is done by pressing the number to be stored (in on hook), then press the > -key followed by the ✓-key. The book can store up to 200 numbers with name. Typing of the name and a confirmation is required. After storing the telephone will go back to standby mode. If the display shows "MEMORY FULL", it is necessary to delete one or more numbers from the telephone book.
(See menu structure page 31)

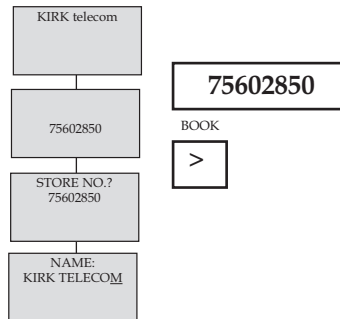



Read BOOK numbers: The telephone book is entered by pressing > (BOOK). For quick-search: press the first letter of the name (using 1-9)(see Chap. 7.2). Call the displayed person by pressing the -key. It is also possible to reach the Phone book Menu in the main menu. Viewing and editing the telephone book can also be done while in conversation.

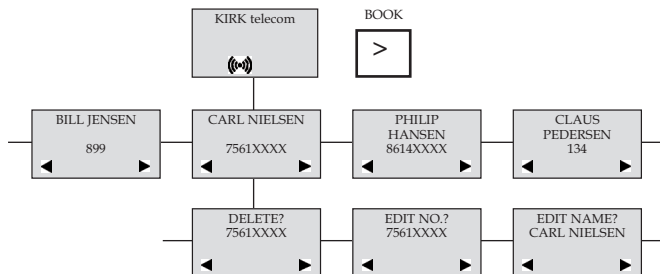



7.9 External services

External services are features placed in the main system, and only available if the handset is subscribed to a KIRK solution. Under External services can be found; “View Clip Stack”, “Delete Clip Stack” and “Local Phone Book”. The Local Phone Book is a common phone book for all handsets subscribed to the actual system, and all handsets subscribed to the system are listed in the phone book. Additional numbers can be added to the phone book by the system administrator.





7.10 MSF Functions

MSF Functions are special functions, which are based on MSF (Message Service Function). The functions require special software in the main system.





7.11 Mail/Text Messages

Available in systems configured with the possibility of sending text messages

At the reception of a text message the envelope icon  appears in the display. The envelope icon is indicating one or more unread messages.

The text message is shown in the display, and when the message is read the envelope icon will disappear.

If the message contains a call-back number, this will be displayed on the bottom line of the display. As long as the call-back number is in the display, it is possible to activate the number by pressing the -key.

1st letter in the display, in front of the timestamp, shows the message status: read (R), unread (N) or locked (L).

Mails include a maximum of 72 letters or digits (2 display screens of 36 each). Call-back number is max. 24 digits (or letters for E-mail).

14 messages can be "stored" in the handset. When receiving a new message, the oldest unlocked will be deleted. Locked messages will not automatically be overwritten, but can manually be deleted. Maximum 7 messages can be locked.





Read a mail

Press the R-key (MAIL) followed by the ✓-key or enter the Mail Menu (in on hook condition).

If the message includes more than 36 letters or digits, the message will run over 2 display screens.

Use the > -key to scroll. To see the **sender** of the mail, press the ✓-key. To leave the mail, press the MENU-key.

Reply a mail

Open the mail by pressing the R-key followed by the ✓-key, press the ✓-key again and use the < > -keys to find the reply feature, press the ✓-key and you are then able to reply the mail. After writing your reply press the ✓-key to confirm.

Forward a mail

Open the mail by pressing the R-key followed by the ✓-key, press the ✓-key again and use the < > -keys to find the forward feature, press the ✓-key twice and you are then able to write the number on the receiver. Confirm with the ✓-key.

Delete all mail

Open the mail stack by pressing the R-key followed by the ✓-key, press the ✓-key again and use the < > -keys to find the delete feature, press the ✓-key and all mails are deleted.



Delete a mail

Open the mail by pressing the R-key followed by the ✓-key, press the ✓-key again and use the < > -keys to find the delete feature, press the ✓-key and the mail is deleted.

Lock/unlock a mail

Open the mail by pressing the R-key followed by the ✓-key, press the ✓-key again and use the < > -keys to find the lock/unlock feature, press the ✓-key and the mail is locked/unlocked.

Write a mail

To write a new mail press the R- key (MAIL), confirm with the ✓-key and write your message. To send the mail press the ✓-key, type the number of the receiver and confirm with the ✓-key.

If one or more mails are stored do as followed: Press the R-key (MAIL) followed by the > -key confirm with the ✓-key and write your message. Press the ✓-key, type the number of the receiver and confirm with the ✓-key. The message is sent.

Note

In case a sent message is not received, the sender will get a message in the display.

The Mail Menu (fig)

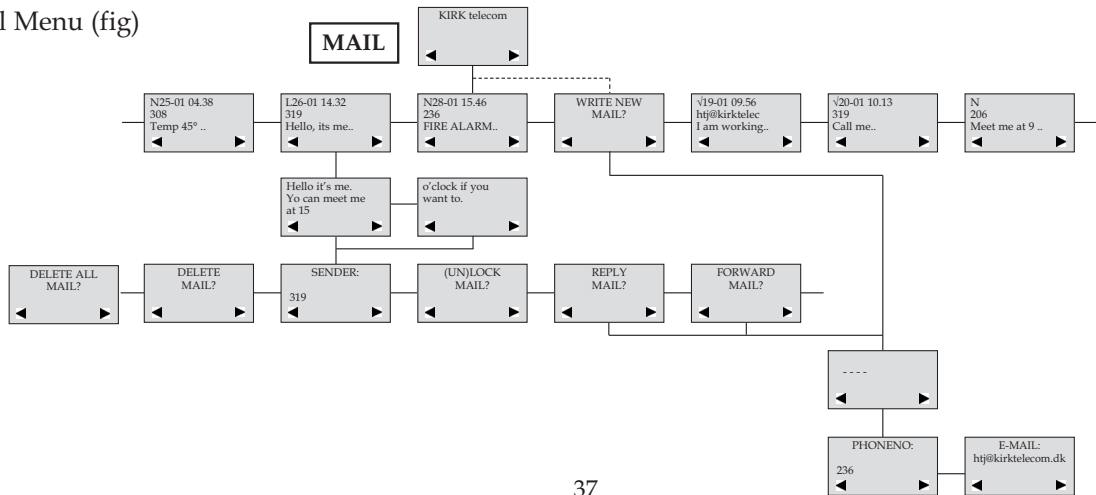



7.12 Speed dial

Please note: To use the speed dial function it is necessary to set “LONG KEY” to “SPEED DIAL” (see Chap 10).

The speed dial list has maximum 11 speed dial numbers. Calling a number from the speed dial list is done by pressing the 0,1,2...9 key with a long key press or by pressing the alarm button key. If no number is assigned to the key it is possible to enter a new number. The number is added to the speed dial list automatically.

To store a number (max. 23 digits) in the speed dial list press MENU and use the < or > keys to reach the Speed dial Menu. Press ✓ to enter the menu. Use the < or > keys to scroll between the list numbers, enter the number and then confirm with ✓. After storing, the telephone will go back to standby mode.

To delete or change a number in the speed dial list press MENU and use the < or > keys to reach the Speed dial Menu. Press ✓ to enter the menu. Use the < or > keys to scroll between the list numbers, press ✓ to select the number in question and then use the < key to delete the existing number. Confirm with ✓ or enter a new number and then confirm with ✓.





8. Date and Time Function

The Date and Time function requires the use of a KIRK Wireless Server and special software in the main system. If the Date and Time function is supported, a clock is shown in the display. The clock shows the time with an accuracy of +/- 1 minute.

If the Date and Time function is supported, then date and time of the incoming or outgoing call is also shown in the CLIP/Redial stack on the 4th line of the display. An icon + date and time shows the status of the call.

If the call is missed, the date and time is displayed: ✕ 29/03 20:28

If the incoming call is received, the date and time is displayed: ➔ 29/03 20:28

If the outgoing call is made, the date and time is displayed: 29/03 20:28 ➔

Date and time is only displayed if CLIP feature is supported by the PBX.



9. Language

There are 10 predefined languages in the handset: English, German, French, Italian, Spanish, Dutch, Portuguese, Swedish, Danish and Norwegian. Select the required language by pressing the ✓-key. If an 11th language is present this will be shown. This language is a specific dealer language and is factory programmed.

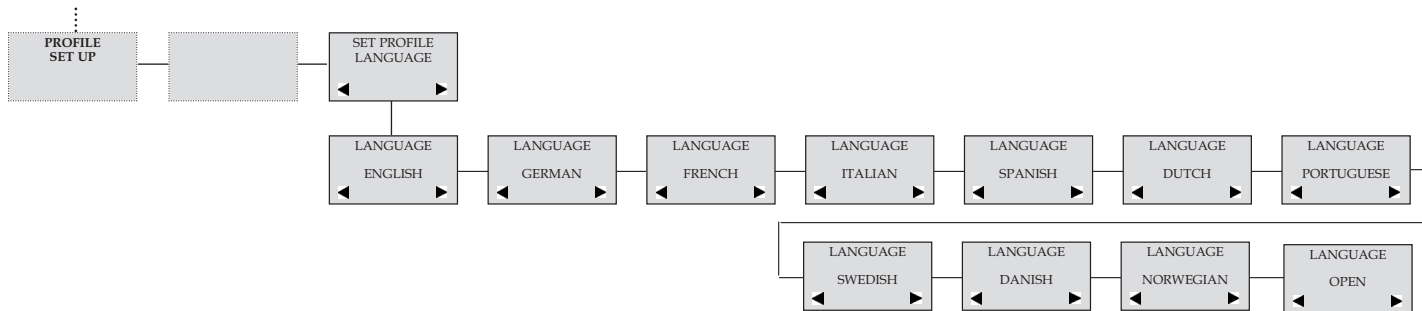



10. Advanced settings

AUTO HOOK: Can be turned on/off using < and >. Confirm with ✓. When turned on, the handset automatically goes off hook when removed from the charger and a call is present. When placing the handset in the charger, the handset automatically goes on hook.

ANY KEY ANSW: Can be turned on/off using < and >. Confirm with ✓. When turned on, all keys work as a Hook key when receiving an incoming call.

LONG KEY: Can be set to "SEND MSF" or "SPEED DIAL" using < and >. Confirm with ✓. When choosing "SEND MSF" an MSF is sent to the KIRK Wireless Server when pressing 0,1,2...9 with a long key press or when pressing the alarm key with a long key press. When choosing "SPEED DIAL" a call is made to the assigned number when pressing 0,1,2...9 with a long key press or when pressing the alarm key with a long key press. If no number is assigned the alarm key it is possible to enter a new number. This number is automatically added to the speed dial list. For more information, see Chap 7.12.

LONG KEY TIM: Used to define the time for how long a key (0,1,2...9) should be pressed before it is detected as a long key press.



A. KEY DELAY: Used to define the time for how long the alarm key should be pressed before the alarm key function is executed.

LS ON B-ANSWER: Can be turned on/off using < and >. Confirm with ✓. When turned on and “B-ANSWER ON” (hands-free) is selected, the handset turns on the loudspeaker automatically (see Chap. 7.4). (Loudspeaker only works on KIRK 4040).

STANDBY TEXT: Can be turned on/off using < and >. Confirm with ✓. When turned off the display shows a local standby text.

HEADS. ALERT: The ringer volume in headset can be set to either “OFF” or 1, 2, 3, 4, 5 (indicated by a bar) using < and >. Confirm with ✓. (only works on KIRK 4040).

HEADSET VOL: The volume in headset can be set to either 1, 2, 3, 4 or 5 (indicated by a bar) using < and >. Confirm with ✓. (only works on KIRK 4040).

OFF HOOK MSF: Can be set to either “NORMAL”, “KEY CLICK” or “KEY BEEP” using < and >. Confirm with ✓. The “OFF HOOK MSF” setting only applies to the behaviour of the handset when an MSF is received and the handset is off hook. When set to “NORMAL” the alert type used is the one defined in the MSF. When set to “KEY CLICK” a key click is produced when receiving an MSF. When set to “KEY BEEP” a key beep is produced when receiving an MSF.

Advanced settings (fig)

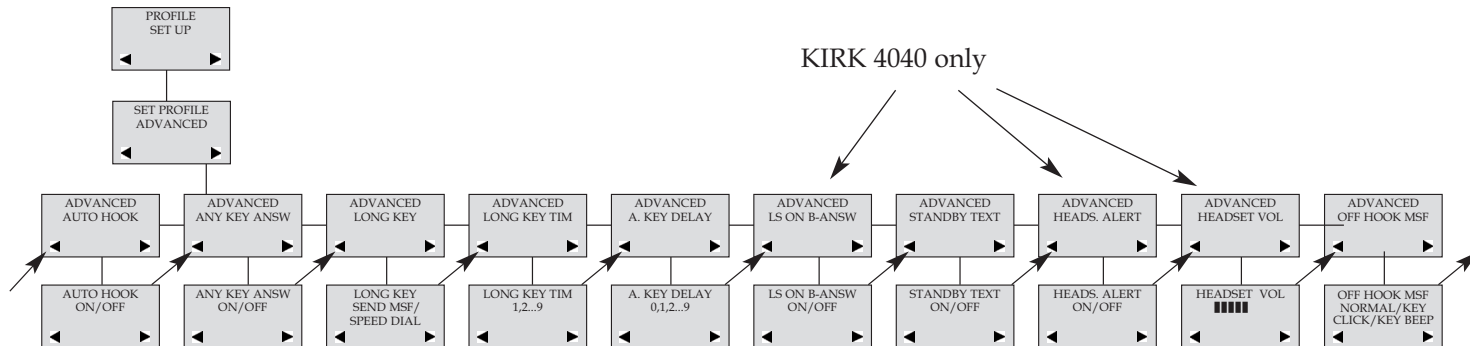

11. Shortcuts

"KEY LOCKED": Press: MENU *. (Display shows )

"SILENT": Press: MENU #. (No sounds) (Display shows )

"PHONE BOOK": Press > (BOOK) in standby

Name search in telephone book: Press the first letter in name and > (BOOK) afterwards

Store a number: Press > (BOOK) after the number (in on hook)

"REDIAL " and "CLIP": Press < (REDIAL) in standby

"MAIL": Press R (MAIL) in on hook

MUTE temporarily the ringer: Press  (MUTE) when the telephone is ringing

MUTE the microphone: Press  (MUTE) when the telephone is off hook

RECALL: Press the INT-key if residential system, else press the R-key

Pause(-): Hold * for one second

Change from pulse to DTMF(T): Hold * for 2 seconds

12. Information

12.1 Error tree

Problem	Check
The telephone freezes	Remove and replace the battery pack. Press  to turn on the telephone
The telephone does not ring	Check whether the ringer is SILENT or RINGER VOL. is OFF
The telephone cannot find a system ID at "SUBSCRIPTION CREATE"	Check whether the system is set to allow subscriptions
The telephone cannot subscribe even if system ID has been found	Check if Access Code is necessary
Not possible to turn on the telephone	Check if battery is connected. If yes, charge the battery
The telephone turn off when receiving a call and going off-hook	Charge the battery. If still a problem change the battery as it might be defective



12.2 Error information

Improper function of the handset might be related to the installation of the KIRK solution or failures related to the main system. Before declaring a handset for repair be sure that the main system is operating properly.

12.3 Polycom® Product Warranty Statement

The software included in this Product (including, without limitation, firmware and all updated thereto, including any software that may be downloaded electronically via the internet or otherwise (the “Software”) is licensed, not sold. Customer shall not reverse compile, disassemble or otherwise reverse engineer, embed within any other software product, or modify in any manner with respect thereto, the Software in whole or in part.

THE TERMS AND CONDITIONS APPLICABLE TO POLYCOM'S LIMITED WARRANTY ARE AS SET FORTH BELOW (AND ARE ALSO INCLUDED IN THE DOCUMENTATION PACKAGED WITH NEW POLYCOM PRODUCTS):





LIMITED WARRANTY. Polycom warrants to the end user (“Customer”) that the product will be free from defects in workmanship and materials, under normal use and service, for one year, or such longer period as Polycom may announce publicly from time to time for particular products, from the date of purchase from Polycom or its authorized reseller. Polycom’s sole obligation under this express warranty shall be, at Polycom’s option and expense, to repair the defective product or part, deliver to Customer an equivalent product or part to replace the defective item, or if neither of the two foregoing options is reasonably available, Polycom may, in its sole discretion, refund to Customer the purchase price paid for the defective product. All products that are replaced will become the property of Polycom. Replacement products or parts may be new or reconditioned. Polycom warrants any replaced or repaired product or part for ninety (90) days from shipment, or the remainder of the initial warranty period, whichever is longer. Products returned to Polycom must be sent prepaid and packaged appropriately for safe shipment, and it is recommended that they be insured or sent by a method that provides for tracking of the package. Responsibility for loss or damage does not transfer to Polycom until the returned item is received by Polycom. The repaired or replaced item will be shipped to Customer, at Polycom's expense, not later than thirty (30) days after Polycom receives the defective product, and Polycom will retain risk of loss or damage until the item is delivered to Customer.



EXCLUSIONS. Polycom will not be liable under this limited warranty if its testing and examination disclose that the alleged defect or malfunction in the product does not exist or results from:

- Failure to follow Polycom's installation, operation, or maintenance instructions.
- Unauthorized product modification or alteration.
- Unauthorized use of common carrier communication services accessed through the product.
- Abuse, misuse, negligent acts or omissions of Customer and persons under Customer's control; or
- Acts of third parties, acts of God, accident, fire, lighting, power surges or outages, or other hazards.

WARRANTY EXCLUSIVE. IF A POLYCOM PRODUCT DOES NOT OPERATE AS WARRANTED ABOVE, CUSTOMER'S SOLE REMEDY FOR BREACH OF THAT WARRANTY SHALL BE REPAIR, REPLACEMENT, OR REFUND OF THE PURCHASE PRICE PAID, AT POLYCOM'S OPTION. TO THE FULL EXTENT ALLOWED BY LAW, THE FOREGOING WARRANTIES AND REMEDIES ARE EXCLUSIVE AND ARE IN LIEU OF ALL OTHER WARRANTIES, TERMS, OR CONDITIONS, EXPRESS OR IMPLIED, EITHER IN FACT OR BY OPERATION OF LAW, STATUTORY OR OTHERWISE, INCLUDING WARRANTIES, TERMS, OR CONDITIONS OF MERCHANTABILITY, FITNESS FOR A PARTICULAR



PURPOSE, SATISFACTORY QUALITY, CORRESPONDENCE WITH DESCRIPTION, AND NON-INFRINGEMENT, ALL OF WHICH ARE EXPRESSLY DISCLAIMED. POLYCOM NEITHER ASSUMES NOR AUTHORIZES ANY OTHER PERSON TO ASSUME FOR IT ANY OTHER LIABILITY IN CONNECTION WITH THE SALE, INSTALLATION, MAINTENANCE OR USE OF ITS PRODUCTS.

SUPPORT & SERVICE AGREEMENTS. If you purchased your product from a Polycom Authorized Reseller, contact the Authorized Reseller for information about support and service agreements applicable to your product. For information on Polycom service, go to the Polycom web site www.polycom.com, products and services menu, or call 1-800-765-9266, outside the US call 1-408-526-9000, or your local Polycom Office, as listed on the Polycom Web site.

LIMITATION OF LIABILITY. TO THE FULL EXTENT ALLOWED BY LAW, POLYCOM EXCLUDES FOR ITSELF AND ITS SUPPLIERS ANY LIABILITY, WHETHER BASED IN CONTRACT OR TORT (INCLUDING NEGLIGENCE), FOR INCIDENTAL, CONSEQUENTIAL, INDIRECT, SPECIAL, OR PUNITIVE DAMAGES OF ANY KIND, OR FOR LOSS OF REVENUE OR PROFITS, LOSS OF BUSINESS, LOSS OF INFORMATION OR DATA, OR OTHER FINANCIAL LOSS ARISING





OUT OF OR IN CONNECTION WITH THE SALE, INSTALLATION, MAINTENANCE, USE, PERFORMANCE, FAILURE, OR INTERRUPTION OF ITS PRODUCTS, EVEN IF POLYCOM OR ITS AUTHORIZED RESELLER HAS BEEN ADVISED OF THE POSSIBILITY OF SUCH DAMAGES, AND LIMITS ITS LIABILITY TO REPAIR, REPLACEMENT, OR REFUND OF THE PURCHASE PRICE PAID, AT POLYCOM'S OPTION. THIS DISCLAIMER OF LIABILITY FOR DAMAGES WILL NOT BE AFFECTED IF ANY REMEDY PROVIDED HEREIN SHALL FAIL OF ITS ESSENTIAL PURPOSE.

DISCLAIMER. Some countries, states, or provinces do not allow the exclusion or limitation of implied warranties or the limitation of incidental or consequential damages for certain products supplied to consumers, or the limitation of liability for personal injury, so the above limitations and exclusions may be limited in their application to you. When the implied warranties are not allowed to be excluded in their entirety, they will be limited to the duration of the applicable written warranty. This warranty gives you specific legal rights which may vary depending on local law.

GOVERNING LAW. This Limited Warranty and Limitation of Liability shall be governed by the laws of the State of California, U.S.A., and by the laws of the United States, excluding their conflicts of laws principles. The United Nations Convention on Contracts for the International Sale of Goods is hereby excluded in its entirety from application to this Limited Warranty and Limitation of Liability.





END-USER LICENSE AGREEMENT FOR POLYCOM SOFTWARE

IMPORTANT - READ CAREFULLY BEFORE USING THE SOFTWARE PRODUCT:

This End-User License Agreement ("Agreement") is a legal agreement between you (either an individual or a single entity) and Polycom, B.V for the POLYCOM® SOFTWARE PRODUCT licensed by Polycom, B.V in Europe, the Middle East, Africa, and Asia Pacific, or the POLYCOM SOFTWARE PRODUCT licensed by Polycom, Inc. in the rest of the world (collectively referred to herein as "POLYCOM"). The SOFTWARE PRODUCT includes computer software as attached hereto and may include associated media, printed materials, and "online" or electronic documentation ("SOFTWARE PRODUCT"). By clicking "I agree" or by installing, copying, or otherwise using the SOFTWARE PRODUCT, you agree to be bound by the terms of this Agreement. If you do not agree to the terms of this Agreement, do not install or use the SOFTWARE PRODUCT, and return it to your place of purchase for a full refund. The SOFTWARE PRODUCT is protected by copyright laws and international copyright treaties, as well as other intellectual property laws and treaties. The SOFTWARE PRODUCT is licensed (not sold) to you, and its use is subject to the terms of this Agreement.





1. GRANT OF LICENSE.

Subject to the terms of this Agreement, POLYCOM grants to you a non-exclusive license to install and use the SOFTWARE PRODUCT on the POLYCOM product with which this SOFTWARE PRODUCT is supplied (the "PRODUCT"). You may use the SOFTWARE PRODUCT only in connection with the use of the PRODUCT. You are not permitted to lease, rent, distribute or sublicense the SOFTWARE PRODUCT or to use the SOFTWARE PRODUCT in a time-sharing arrangement or in any other unauthorized manner. Further, no license is granted to you in the human readable code of the SOFTWARE PRODUCT (source code). Except as provided below, this License Agreement does not grant you any rights to patents, copyrights, trade secrets, trademarks, or any other rights in respect to the SOFTWARE PRODUCT.

2. DESCRIPTION OF OTHER RIGHTS AND LIMITATIONS.

2.1 Limitations on Reverse Engineering, Decompilation, and Disassembly. You may not reverse engineer, decompile, or disassemble the SOFTWARE PRODUCT, except and only to the extent that such activity is expressly permitted by applicable law notwithstanding this limitation. The SOFTWARE PRODUCT is licensed as a single product. Its component parts may not be separated for use on more than one PRODUCT.





2.2 Back-up. Except as expressly provided for under this Agreement you may not copy the SOFTWARE PRODUCT; except, however, you may keep one copy of the SOFTWARE PRODUCT and, if applicable, one copy of any previous version, for back-up purposes, only to be used in the event of failure of the original. All copies of the SOFTWARE PRODUCT must be marked with the proprietary notices provided on the original SOFTWARE PRODUCT. You may not reproduce the supporting documentation accompanying the SOFTWARE PRODUCT.

2.3 Modifications. You may not modify, translate or create derivative works of the SOFTWARE PRODUCT.

2.4 Proprietary Notices. You may not remove or obscure any proprietary notices on or in the SOFTWARE PRODUCT or the supporting documentation.

2.5 Software Transfer. You may permanently transfer all of your rights under this Agreement, provided you retain no copies, you transfer all of the SOFTWARE PRODUCT (including all component parts, the media and printed materials, any upgrades, this Agreement, and, if applicable, the Certificate of Authenticity), and the recipient agrees to the terms of this Agreement. If the SOFTWARE PRODUCT is an upgrade, any transfer must include all prior versions of the SOFTWARE PRODUCT. However, if the SOFTWARE PRODUCT is marked "Not for Resale" or "NFR", you may not resell it or otherwise transfer it for value.





2.6 Copyright. All title and copyrights in and to the SOFTWARE PRODUCT (including but not limited to any images, photographs, animations, video, audio, music, text, and "applets" incorporated into the SOFTWARE PRODUCT), the accompanying printed materials, and any copies of the SOFTWARE PRODUCT are owned by POLYCOM or its suppliers. The SOFTWARE PRODUCT is protected by copyright laws and international treaty provisions. Title, ownership rights, and intellectual property rights in the SOFTWARE PRODUCT shall remain in POLYCOM or its suppliers. Title and related rights in the content accessed through the SOFTWARE PRODUCT is the property of such content owner and may be protected by applicable law. This Agreement gives you no rights in such content.

2.7 Confidentiality. The SOFTWARE PRODUCT contains valuable proprietary information and trade secrets of POLYCOM and its suppliers and you shall protect the confidentiality of, and avoid disclosure and unauthorized use of, the SOFTWARE PRODUCT.

2.8 Dual-Media Software. You may receive the SOFTWARE PRODUCT in more than one medium. Regardless of the type or size of medium you receive, you may use only one medium that is appropriate for your single PRODUCT. You may not use or install the other medium on another PRODUCT.

2.9 Reservation. POLYCOM reserves all rights in the SOFTWARE PRODUCT not expressly granted to you in this Agreement.





3. SUPPORT SERVICES.

POLYCOM may provide you with support services related to the SOFTWARE PRODUCT("SUPPORT SERVICES "). Use of SUPPORT SERVICES is governed by the POLYCOM policies and programs described in the POLYCOM - provided materials. Any supplemental software code provided to you as part of the SUPPORT SERVICES is considered part of the SOFTWARE PRODUCT and is subject to the terms and conditions of this Agreement. With respect to technical information you provide to POLYCOM as part of the SUPPORT SERVICES, POLYCOM may use such information for its business purposes, including for product support and development. POLYCOM will not utilize such technical information in a form that personally identifies you.

4. TERMINATION.

Without prejudice to any other rights, POLYCOM may terminate this Agreement if you fail to comply with any of the terms and conditions of this Agreement. In such event, you must destroy all copies of the SOFTWARE PRODUCT and all of its component parts. You may terminate this Agreement at any time by destroying the SOFTWARE PRODUCT and all of its component parts.





5. UPGRADES.

If the SOFTWARE PRODUCT is labeled as an upgrade, you must be properly licensed to use the software identified by POLYCOM as being eligible for the upgrade in order to use the SOFTWARE PRODUCT. A SOFTWARE PRODUCT labeled as an upgrade replaces and/or supplements the software that formed the basis for your eligibility for the upgrade. You may use the resulting upgraded SOFTWARE PRODUCT only in accordance with the terms of this Agreement. If the SOFTWARE PRODUCT is an upgrade of a component of a package of software programs that you licensed as a single product, the SOFTWARE PRODUCT may be used and transferred only as part of that single SOFTWARE PRODUCT package and may not be separated for use on more than one PRODUCT.

6. WARRANTY AND WARRANTY EXCLUSIONS.

6.1 Limited Warranty. POLYCOM warrants that (a) the SOFTWARE PRODUCT will perform substantially in accordance with the accompanying documentation for a period of ninety (90) days from the date of receipt by you, and (b) any SUPPORT SERVICES provided by POLYCOM shall be substantially as described in applicable written materials provided to you by POLYCOM, and POLYCOM support engineers will make commercially reasonable efforts to solve any problem issues. POLYCOM does not warrant that your use of the SOFTWARE PRODUCT will be uninterrupted or error free, or that all defects in the SOFTWARE PRODUCT will be corrected. POLYCOM's sole





obligation under this express warranty shall be, at POLYCOM's option and expense, to refund the purchase price paid by you for any defective software product which is returned to POLYCOM with a copy or your receipt, or to replace any defective media with software which substantially conforms to applicable POLYCOM published specifications. Any replacement SOFTWARE PRODUCT will be warranted for the remainder of the original warranty period or thirty (30) days, whichever is longer.

6.2 Warranties Exclusive. IF THIS SOFTWARE PRODUCT DOES NOT OPERATE AS WARRANTED ABOVE, YOUR SOLE REMEDY FOR BREACH OF THAT WARRANTY SHALL BE REPAIR, REPLACEMENT, OR REFUND OF THE PURCHASE PRICE PAID, AT POLYCOM'S OPTION. TO THE FULL EXTENT ALLOWED BY LAW, THE FOREGOING WARRANTIES AND REMEDIES ARE EXCLUSIVE AND ARE IN LIEU OF ALL OTHER WARRANTIES, TERMS, OR CONDITIONS, EXPRESS OR IMPLIED, EITHER IN FACT OR BY OPERATION OF LAW, STATUTORY OR OTHERWISE, INCLUDING WARRANTIES, TERMS, OR CONDITIONS OF MERCHANTABILITY, FITNESS FOR A PARTICULAR PURPOSE, SATISFACTORY QUALITY, CORRESPONDENCE WITH DESCRIPTION, AND NON-INFRINGEMENT, ALL OF WHICH ARE EXPRESSLY DISCLAIMED. POLYCOM NEITHER ASSUMES NOR AUTHORIZES ANY OTHER PERSON TO ASSUME FOR IT ANY OTHER LIABILITY



IN CONNECTION WITH THE SALE, INSTALLATION, MAINTENANCE OR USE OF THIS SOFTWARE PRODUCT. POLYCOM SHALL NOT BE LIABLE UNDER THIS WARRANTY IF ITS TESTING AND EXAMINATION DISCLOSE THAT THE ALLEGED DEFECT OR MALFUNCTION IN THE SOFTWARE PRODUCT DOES NOT EXIST OR WAS CAUSED BY YOUR OR ANY THIRD PERSON'S MISUSE, NEGLIGENCE, IMPROPER INSTALLATION OR TESTING, UNAUTHORIZED ATTEMPTS TO MODIFY THE PRODUCT, OR ANY OTHER CAUSE BEYOND THE RANGE OF THE INTENDED USE, OR BY ACCIDENT, FIRE, LIGHTNING, POWER CUTS OR OUTAGES, OTHER HAZARDS, OR ACTS OF GOD.

7. LIMITATION OF LIABILITY.

TO THE MAXIMUM EXTENT PERMITTED BY APPLICABLE LAW, IN NO EVENT SHALL POLYCOM OR ITS SUPPLIERS BE LIABLE FOR ANY SPECIAL, INCIDENTAL, INDIRECT, OR CONSEQUENTIAL DAMAGES WHATSOEVER (INCLUDING, WITHOUT LIMITATION, DAMAGES FOR LOSS OF BUSINESS PROFITS, BUSINESS INTERRUPTION, LOSS OF BUSINESS INFORMATION, OR ANY OTHER PECUNIARY LOSS) ARISING OUT OF THE USE OF OR INABILITY TO USE THE SOFTWARE PRODUCT OR THE PROVISION OF OR FAILURE TO PROVIDE SUPPORT SERVICES, EVEN IF POLYCOM HAS BEEN ADVISED OF THE POSSIBILITY OF SUCH



DAMAGES. IN ANY CASE, POLYCOM'S ENTIRE LIABILITY SHALL BE LIMITED TO THE GREATER OF THE AMOUNT ACTUALLY PAID BY YOU FOR THE SOFTWARE PRODUCT OR U.S. \$5.00. PROVIDED, HOWEVER, IF YOU HAVE ENTERED INTO A POLYCOM SUPPORT SERVICES AGREEMENT, POLYCOM'S ENTIRE LIABILITY REGARDING SUPPORT SERVICES SHALL BE GOVERNED BY THE TERMS OF THAT AGREEMENT.

8. DISCLAIMER.

Some countries, states, or provinces do not allow the exclusion or limitation of implied warranties or the limitation of incidental or consequential damages for certain products supplied to consumers, or the limitation of liability for personal injury, so the above limitations and exclusions may be limited in their application to you. When the implied warranties are not allowed to be excluded in their entirety, they will be limited to the duration of the applicable written warranty. This warranty gives you specific legal rights which may vary depending on local law.

9. EXPORT CONTROLS.

The SOFTWARE PRODUCT may not be downloaded or otherwise exported or re-exported (i) into (or to a national or resident of) Cuba, Iraq, Libya, North Korea, Yugoslavia, Iran, Syria, Republic of Serbia, or any other country to





which the U.S. has embargoed goods; or (ii) to anyone on the U.S. Treasury Department's list of Specially Designated Nationals or the U.S. Commerce Department's Table of Denial Orders. By downloading or using the SOFTWARE PRODUCT, you are agreeing to the foregoing and you are representing and warranting that you are not located in, under the control of, or a national or resident of any such country or on any such list. If you obtained this SOFTWARE PRODUCT outside of the United States, you are also agreeing that you will not export or re-export it in violation of the laws of the country in which it was obtained.

10. MISCELLANEOUS.

10.1 Governing Law. This Agreement shall be governed by the laws of the State of California as such laws are applied to agreements entered into and to be performed entirely within California between California residents, and by the laws of the United States. The United Nations Convention on Contracts for the International Sale of Goods (1980) is hereby excluded in its entirety from application to this Agreement.

10.2 General. This Agreement represents the complete agreement concerning this license and may be amended only by a writing executed by both parties. If any provision of this Agreement is held to be unenforceable, such provision shall be reformed only to the extent necessary to make it enforceable.





10.3 Contact. If you have any questions concerning this Agreement, or if you desire to contact POLYCOM for any reason, please contact the POLYCOM office serving your country.

10.4 U.S. Government Restricted Rights. The SOFTWARE PRODUCT and documentation are provided with RESTRICTED RIGHTS. The SOFTWARE PRODUCT programs and documentation are deemed to be "commercial computer software" and "commercial computer software documentation", respectively, pursuant to DFAR Section 227.7202 and FAR 12.212(b), as applicable. Any use, modification, reproduction, release, performance, display or disclosure of the SOFTWARE PRODUCT programs and/or documentation by the U.S. Government or any of its agencies shall be governed solely by the terms of this Agreement and shall be prohibited except to the extent expressly permitted by the terms of this Agreement. Any technical data provided that is not covered by the above provisions is deemed to be "technical data-commercial items" pursuant to DFAR Section 227.7015(a). Any use, modification, reproduction, release, performance, display or disclosure of such technical data shall be governed by the terms of DFAR Section 227.7015(b).





12.4. Technical information

Approvals

Acoustics:	TBR10
Electrical:	TBR6 (DECT RF)
Access profile:	TBR 22 (GAP)
EMC:	EN 301 489 -1/-6
EN 301 406	
EN 60950-1	
EN 50371	
EN 61000-3-2	
EN 61000-3-3	

Size and weight

Size:	149 x 50 x 28 mm
Weight:	123 g including battery \pm 10 g

Capacity

Active talking time	12 hours
Stand-by time	150 hours

Power output

Maximum average output power emitted in average of six minutes: <20.0 mW.





12.5 International Regulatory and Product Information



This KIRK product has been marked with the CE mark. This mark indicates compliance with EEC Directives 89/336/EEC, 73/23/EEC 1999/5/EC. A full copy of the Declaration of Conformity can be obtained from Polycom Ltd, 270 Bath Road, Slough, Berkshire, SL1 4DX, UK.

Česky [Czech]:

Polycom (UK) Ltd tímto prohlašuje, že tento *KIRK 4020 / 4040 handset* je ve shodě se základními požadavky a dalšími příslušnými ustanoveními směrnice 1999/5/ES.

Dansk [Danish]:

Undertegnede Polycom (UK) Ltd erklærer herved, at følgende udstyr *KIRK 4020 / 4040 handset* overholder de væsentlige krav og øvrige relevante krav i direktiv 1999/5/EF.

Deutsch [German]:

Hiermit erklärt Polycom (UK) Ltd, dass sich das Gerät *KIRK 4020 / 4040 handset* in Übereinstimmung mit den grundlegenden Anforderungen und den übrigen einschlägigen Bestimmungen der Richtlinie 1999/5/EG befindet.



- Eesti [Estonian]:** Käesolevaga kinnitab Polycom (UK) Ltd seadme *KIRK 4020 / 4040 handset* vastavust direktiivi 1999/5/EÜ põhinõuetele ja nimetatud direktiivist tulenevatele teistele asjakohastele sätetele.
- English:** Hereby, Polycom (UK) Ltd. declares that this *KIRK 4020 / 4040 handset* is in compliance with the essential requirements and other relevant provisions of Directive 1999/5/EC.
- Español [Spanish]:** Por medio de la presente Polycom (UK) Ltd declara que el *KIRK 4020 / 4040 handset* cumple con los requisitos esenciales y cualesquiera otras disposiciones aplicables o exigibles de la Directiva 1999/5/CE.
- Ελληνική [Greek]:** ΜΕ ΤΗΝ ΠΑΡΟΥΣΑ Polycom (UK) Ltd ΔΗΛΩΝΕΙ ΟΤΙ *KIRK 4020 / 4040 handset* ΣΥΜΜΟΡΦΩΝΕΤΑΙ ΠΡΟΣ ΤΙΣ ΟΥΣΙΩΔΕΙΣ ΑΠΑΙΤΗΣΕΙΣ ΚΑΙ ΤΙΣ ΛΟΙΠΕΣ ΣΧΕΤΙΚΕΣ ΔΙΑΤΑΞΕΙΣ ΤΗΣ ΟΔΗΓΙΑΣ 1999/5/EK.
- Français [French]:** Par la présente Polycom (UK) Ltd déclare que l'appareil *KIRK 4020 / 4040 handset* est conforme aux exigences essentielles et aux autres dispositions pertinentes de la directive 1999/5/CE.
- Italiano [Italian]:** Con la presente Polycom (UK) Ltd dichiara che questo *KIRK 4020 / 4040 handset* è conforme ai requisiti essenziali ed alle altre disposizioni pertinenti stabilite dalla direttiva 1999/5/CE.
- Íslenska [Icelandic]:** Hér með lýsir Polycom (UK) Ltd yfir því að *KIRK 4020 / 4040 handset* er í samræmi við grunnkröfur og aðrar kröfur, sem gerðar eru í tilskipun 1999/5/EC
- Latviski [Latvian]:** Ar šo Polycom (UK) Ltd deklarē, ka *KIRK 4020 / 4040 handset* atbilst Direktīvas 1999/5/EK būtiskajām prasībām un citiem ar to saistītajiem noteikumiem.



- Lietuvių [Lithuanian]:** Šiuo Polycom (UK) Ltd deklaruoja, kad šis *KIRK 4020 / 4040 handset* atitinka esminius reikalavimus ir kitas 1999/5/EB Direktyvos nuostatas.
- Nederlands [Dutch]:** Hierbij verklaart Polycom (UK) Ltd dat het toestel *KIRK 4020 / 4040 handset* in overeenstemming is met de essentiële eisen en de andere relevante bepalingen van richtlijn 1999/5/EG.
- Malti [Maltese]:** Hawnhekk, Polycom (UK) Ltd, jiddikjara li dan [il-mudel tal-prodott] jikkonforma mal-htigijiet essenzjali u ma provvedimenti oħrajn relevanti li hemm fid-Dirrettiva 1999/5/EC.
- Magyar [Hungarian]:** Alulírott, Polycom (UK) Ltd nyilatkozom, hogy a *KIRK 4020 / 4040 handset* megfelel a vonatkozó alapvető követelményeknek és az 1999/5/EC irányelv egyéb előírásainak.
- Norsk [Norwegian]:** Polycom (UK) Ltd erklærer herved at utstyret *KIRK 4020 / 4040 handset* er i samsvar med de grunnleggende krav og øvrige relevante krav i direktiv 1999/5/EF.
- Polski [Polish]:** Niniejszym Polycom (UK) Ltd oświadcza, że *KIRK 4020 / 4040 handset* jest zgodne z zasadniczymi wymaganiami oraz innymi stosownymi postanowieniami Dyrektywy 1999/5/WE.
- Português [Portuguese]:** Polycom (UK) Ltd declara que este *KIRK 4020 / 4040 handset* está conforme com os requisitos essenciais e outras disposições da Directiva 1999/5/CE.
- Slovensko [Slovenian]:** Polycom (UK) Ltd izjavlja, da je ta *KIRK 4020 / 4040 handset* v skladu z bistvenimi zahtevami in ostalimi relevantnimi določili direktive 1999/5/ES.





- Slovensky [Slovak]:** Polycom (UK) Ltd týmto vyhlasuje, že *KIRK 4020 / 4040 handset* spĺňa základné požiadavky a všetky príslušné ustanovenia Smernice 1999/5/ES.
- Suomi [Finnish]:** Polycom (UK) Ltd vakuuttaa täten että *KIRK 4020 / 4040 handset* tyyppinen laite on direktiivin 1999/5/EY oleellisten vaatimusten ja sitä koskevien direktiivin muiden ehtojen mukainen.
- Svenska [Swedish]:** Härmed intygar Polycom (UK) Ltd att denna *KIRK 4020 / 4040 handset* står i överensstämmelse med de väsentliga egenskapskrav och övriga relevanta bestämmelser som framgår av direktiv 1999/5/EG.



The WEEE Marking on this equipment indicates that the product must not be disposed of with unsorted waste, but must be collected separately.





12.5.1 Important Safety Instructions

Before using your telephone equipment, you should always follow basic safety instruction to reduce the risk of fire, electrical shock and injury to persons, and damage to property.

1. Read and understand all instructions.
2. Follow all warnings and instructions including those marked on the product.
3. Unplug this product before cleaning. Do not use liquid cleaners or aerosol cleaners. Use damp cloth for cleaning.
4. Do not install the telephone equipment in the bathroom or near a wash bowl, kitchen sink, or laundry tub, in a wet basement, or near a swimming pool.
5. Slots or openings in the equipment are provided for ventilation to protect it from over-heating. These openings must not be blocked or covered.
6. The product should be operated only from the type of power source indicated on the instructions. If you are not sure of the type of power supply, consult your dealer or local power company.
7. Do not overload wall outlets and extension cords as this can result in fire or electrical shock.
8. Never push objects of any kind into this product through cabinet slots as they may touch dangerous voltage points or short out parts that could result in fire, electrical shock, or injury. Never spill liquid of any kind into this product.
9. To reduce the risk of electrical shock or burns, do not disassemble this product. Opening or removing covers may expose you to dangerous voltages, dangerous electrical current, or other risks. Incorrect reassemble can cause electrical shock when the appliance is subsequently used. If the product need repair, consult your dealer.
10. Refer servicing to qualified service personnel.



11. Avoid using telephone during an electrical storm. There may be a risk of electrical shock from lightning.
12. Do not use the telephone to report a gas leak in the vicinity of the leak.
13. Do not place the base or charger near microwave ovens, radio equipment, or non-ground connected televisions. These appliances may cause electrical interference to the base or handset.
14. The charger must be placed on a hard, flat surface and connected to a functional power source.
15. This telephone will not operate in the event of a blackout. Please keep a backup phone for emergencies.
16. Installation must be performed in accordance with all relevant national wiring rules.
17. Plug acts as Disconnect Device - The socket outlet to which this apparatus is connected must be installed near the equipment and must always be readily accessible.

Intrinsic safety

Do not use the handset in conditions where there is a danger of electrically ignited explosions.

Exposure to sunlight, heat and moisture.

Do not expose the wireless phone to direct sunlight for long periods. Keep the wire-less phone away from excessive heat and moisture.

Spare parts and accessories

Use only approved spare parts and accessories. The operation of non- approved parts cannot be guaranteed and may even cause damage.

Power failure

In the event of a power failure or flat battery, you cannot use the handset to make or receive calls.



Battery Precautions

1. Periodically clean the charge contacts on both the charger and handset.
2. Exercise care in handling batteries in order not to short the batteries with conducting materials such as rings, bracelets, and keys. The batteries or conducting material may overheat and cause burns or fire.
3. Do not open or mutilate the batteries. Released electrolyte is corrosive and may cause damage to the eyes or skin. The electrolyte may be toxic if swallowed.
4. During charging batteries heat up. This is normal and not dangerous.
5. Lithium cell installation Caution -Danger of Explosion if Battery is incorrectly replaced. Replace only with the same or equivalent type recommended by the manufacturer. Dispose of used batteries according to the manufacturer's instructions.

Note: This equipment has been tested and found to comply with the limits for a class B digital device, pursuant to local regulations. These limits are designed to provide reasonable protection against harmful interference in a residential installation. This equipment generates, uses and can radiate radio frequency energy and, if not installed and used in accordance with the instructions, may cause harmful interference to radio communications. However, there is no guarantee that interference will not occur in a particular installation. If this equipment does cause harmful interference to radio or television reception, which can be determined by turning the equipment off and on, the user is encouraged to try to correct the interference by one or more of the following measures:

- Reorient or relocate the receiving antenna.
- Increase the separation between the equipment and receiver.
- Connect the equipment into an outlet on a circuit different from that to which the receiver is connected.
- Consult the dealer or an experienced radio/TV technician for help.



FCC Note: This device complies with part 15 of the FCC rules. Operation is subject to the following two conditions: (1) This device may not cause harmful interference, and (2) this device must accept any interference received, including interference that may cause undesired operation. In accordance with part 15 of the FCC rules, the user is cautioned that any changes or modifications not expressly approved by Polycom Inc. could void the user's authority to operate the equipment.

SAR: Device has been tested for SAR compliance for head and body worn configurations. The highest reported SAR values are: 4020: 0.037 W/kg head, 0.01 W/kg body and 4040: 0.037 W/kg head, 0.01 W/kg body.

IC Note: Operation is subject to the following two conditions: (1) This device may not cause interference, and (2) this device must accept any interference, including interference that may cause undesired operation of the device. The Term "IC": before the certification/ registration number only signifies that the Industry Canada technical specifications were met.

Privacy of communications may not be ensured when using this telephone.

This Class [B] digital apparatus complies with Canadian ICES-003.

Cet appareil numérique de la classe [B] est conforme à la norme NMB-003 du Canada.

Power Outage: In the event of a power outage, your wireless telephone will not operate. The wireless telephone requires electricity for operation. You should have a telephone which does not require electricity available for use during power outages.

Information to user: The users manual or instruction manual for an intentional or unintentional radiator shall caution the user that changes or modifications not expressly approved by the party responsible for compliance could void the user's authority to operate the equipment.



NOTE EMC: Cet appareil a été soumis à un essai et jugé conforme aux normes régissant les limites établies pour un dispositif numérique de classe B, conformément aux règlements locaux. Ces limites visent à assurer une protection raisonnable contre des interférences pouvant nuire à l'appareil utilisé dans un secteur résidentiel. Cet équipement génère et utilise des radiofréquences, et peut en émettre. S'il n'est pas installé et utilisé selon les directives fournies, il risque de perturber les radiocommunications. L'exploitation de cet appareil dans un secteur particulier est toutefois susceptible de produire des interférences nuisibles. Si cet équipement provoque des interférences lors de la réception des radiofréquences ou des fréquences de télévision, ce qui peut être vérifié en mettant l'appareil hors tension, puis en le remettant sous tension, l'utilisateur doit prendre l'une des mesures suivantes pour corriger la situation:

- réorienter ou relocaliser l'antenne de réception;
- augmenter la distance entre l'appareil et l'antenne de réception;
- brancher l'appareil à une prise d'un circuit différent de celui auquel l'antenne est branchée;
- consulter le détaillant ou un technicien en radiotélévision d'expérience pour obtenir de l'aide.





12.5.2 Limited Warranty

This limited, non-transferable warranty is provided to the original purchaser. The product is warranted to be free from defects in materials and workmanship under normal installation, use and service for a period of one (1) year from the date of purchase as shown on the purchaser's receipt. Our obligation under this warranty is limited to repair or replacement (at our option) of the product or any part(s) which are defective provided that the product is returned to the original place of purchase or an authorized service location during the warranty period. Products returned must be accompanied by a copy of the purchase receipt. In the absence of a purchase receipt, the warranty period shall be one (1) year from the date of manufacture. Repair or replacement of the product is your sole and exclusive remedy.

If the product is repaired, reconditioned component parts or materials may be used. If the product is replaced, we may replace it with a new or reconditioned product of the same or similar design. The repaired product will be warranted for either (a) 90 days or (b) the remainder of the original one (1) year warranty period, whichever is longer.

This warranty does not apply to the defects outside of our control, including but not limited to acts of God, fire, flood and damage while in transit to service facility. We do not warranty that the product will be compatible with any telephone equipment, systems or party lines.

This warranty shall be void if the product is damaged as a result of defacement, misuse, abuse, neglect, accident, destruction or alteration of the serial number, improper electrical voltages or currents, repair, alteration or maintenance by any person or party other than our authorized service facility, or any violation of instructions furnished by us.

This warranty is also void if this product is removed from the country in which it was purchased by the original purchaser, if it





is used in a country in which it is not registered for use, or if it is used in a country for which it was not designed. Due to variations in telephone systems and communications laws, this product may be illegal for use in some countries. We assume no responsibilities for damages or penalties incurred resulting from the use of this product in a manner or location other than that for which it was intended.

THIS LIMITED WARRANTY IS IN LIEU OF ALL OTHER WARRANTIES EXPRESS OR IMPLIED. ANY IMPLIED WARRANTIES INCLUDING BUT NOT LIMITED TO THE IMPLIED WARRANTIES OF MERCHANTABILITY AND FITNESS FOR A PARTICULAR PURPOSE, SHALL BE LIMITED TO THE DURATION OF THIS WRITTEN LIMITED WARRANTY. WE DISCLAIM ANY LIABILITY FOR DAMAGES FOR LOSS OF USE OF THE PRODUCTS, LOSS OF TIME, INCONVENIENCE, INJURY TO ANY PERSON, OR DAMAGE TO PROPERTY CAUSED BY THE PRODUCT, LOSS OF REVENUE OR PROFIT OR DAMAGES FOR ANY FAILURE TO PERFORM. IN NO EVENT SHALL WE BE LIABLE FOR ANY SPECIAL, INCIDENTAL, PUNITIVE OR CONSEQUENTIAL DAMAGES EVEN IF WE ARE ADVISED OF THE POSSIBILITY OF SUCH DAMAGES.

Some states do not allow limitations on how long an implied warranty lasts, so the above limitations may not apply to you. This warranty is the sole and exclusive warranty provided for the product. There are no other express warranties. This warranty gives you specific legal rights, and you may also have other rights, which vary from state to state.









Polycom (Denmark)
Langmarksvej 34
DK-8700 Horsens
Tel. +45 7560 2850
Fax +45 7560 2851
emeaddk@polycom.com
www.polycom.com

Polycom Headquarters
4750 Willow Road
Pleasanton
CA 94588 (T)

©2007 Polycom, Inc. All rights reserved.
Specifications subject to change without notice.

